

Caution

- Tie down long or wide loads at the front and rear of the vehicle with non-elastic straps. If it looks like it can catch some air, it will. **TIE IT DOWN!**
- When loading your surf gear or kayak, ensure that it is mounted correctly using the tie downs provided and is positioned centrally, parallel to the vehicle.
- Check straps periodically during travel and tighten if necessary. Replace any straps that are worn or frayed before using (see your Prorack dealer).

Important Warning

- It is critical that all Prorack racks and accessories be properly and securely attached to your vehicle. Improper attachment could result in an automobile accident, and could cause serious bodily injury or death to you or to others.
- You are responsible for securing the racks and accessories to your car, checking the attachments prior to use, and periodically inspecting the products for adjustment, wear, and damage. Therefore, you must read and understand all of the instructions and cautions supplied with your Prorack product prior to installation or use.
- If you do not understand all of the instructions and cautions, or if you have no mechanical experience and are not thoroughly familiar with the installation procedures, you should have the product installed by a professional installer such as a boat carrier specialist.

Kit Contents

Item	Component	Qty
1	Saddle	4
2	Heavy Duty Strap	2
3	Pad	4
4	Hook	2
5	Rope	2

This product is designed to work with Prorack Aero, Standard, Trade and other Round Bars.

Minimum Crossbar Spread 61 cm

Max Load 36 kg

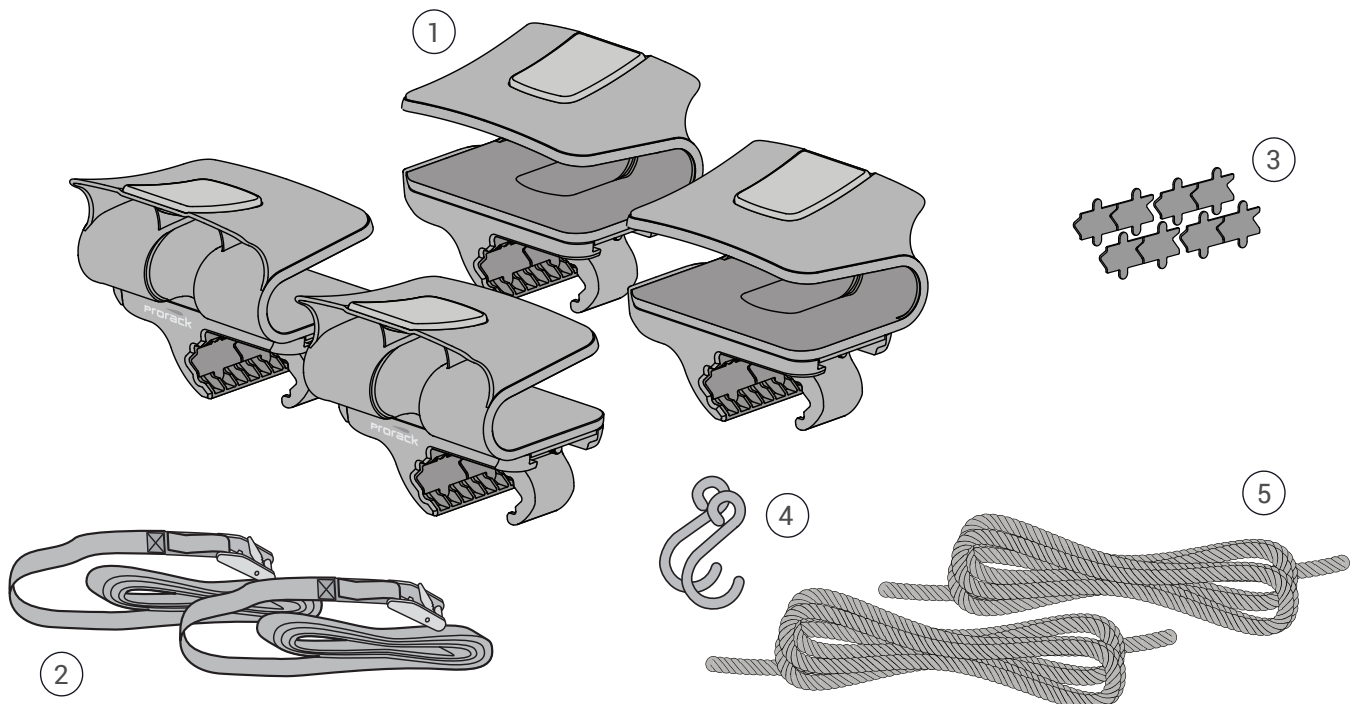

1 Install pads

Open the clamp wide enough to fit around your roof rack bars.

Install the four pads. Press each pad into place. Use one pad for each saddle.

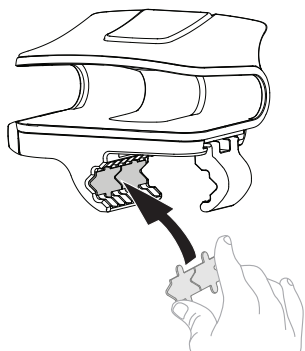

2 Put saddle on roof rack bars.

Place your saddle onto the roof rack bars.

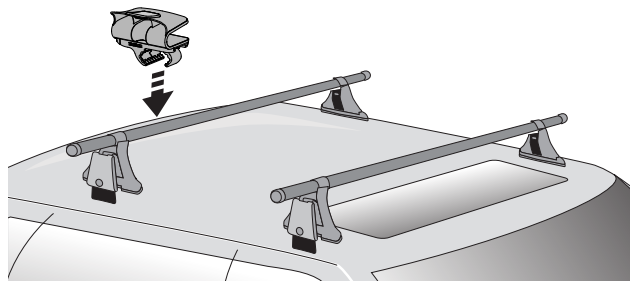

3 Close Clamp

Push clamp closed against roof rack bar.

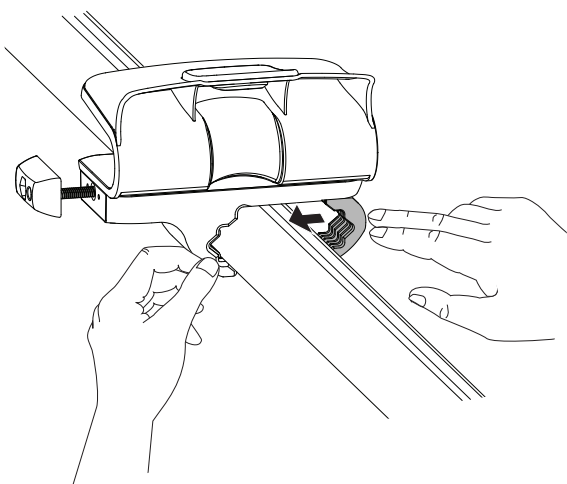

4 Tighten clamp

Tighten the clamp completely.

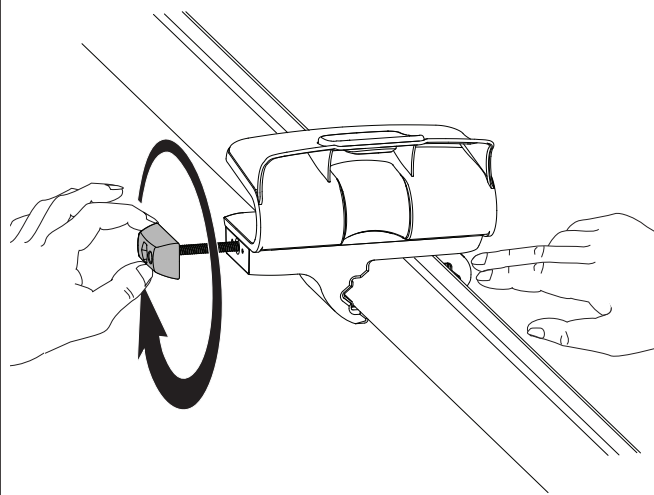

5 Install the other saddles

Using the same procedure install the other saddles.

Space the saddles based on the width of your boat then proceed to the next step to make adjustments for the best fit for you boat.

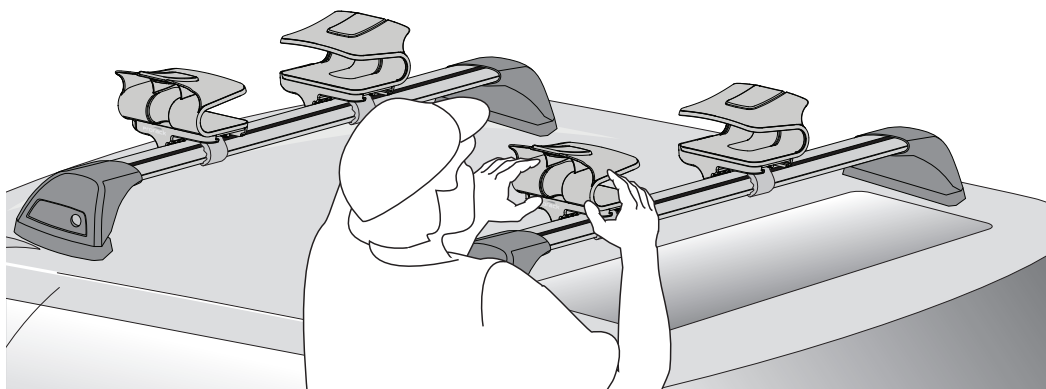

Key features: flexible saddles

The Kayak Carrier is designed to flex and conform to your boat when you tighten the straps. Keep this in mind as you adjust position in the next step, and prepare to tie down your boat.

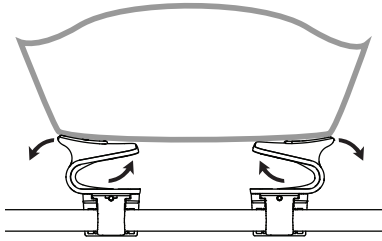

EXAMPLE A

Here the shape of the hull will cause the saddles to bend up from the inside.

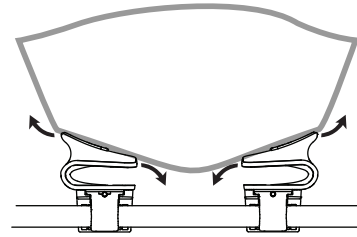

EXAMPLE B

In this example the hull will force the saddles to bend down from the outside.

6 Load boat and adjust position

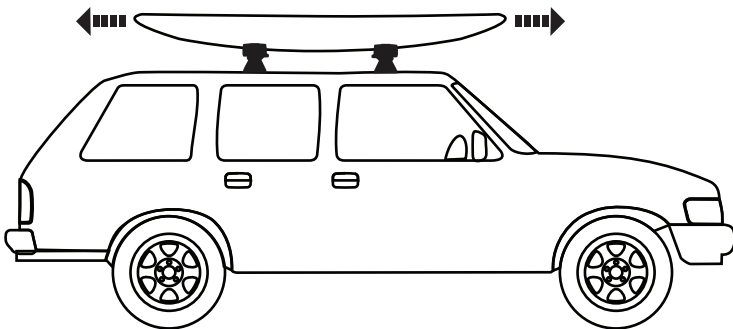

7 Center boat on saddles

Adjust saddles as necessary.

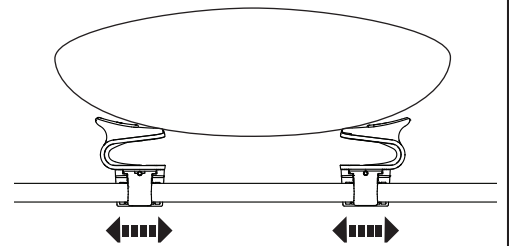

8 Tie down

Use straps to secure boat to roof rack bars. Loop strap around front roof rack bar as shown.

NOTE: Be sure that strap is INBOARD of roof rack leg. Repeat for rear roof rack bar.

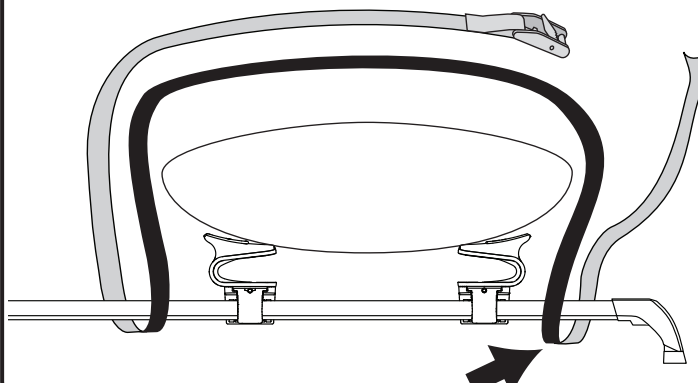

9 Thread free end of strap through buckle and pull to tighten

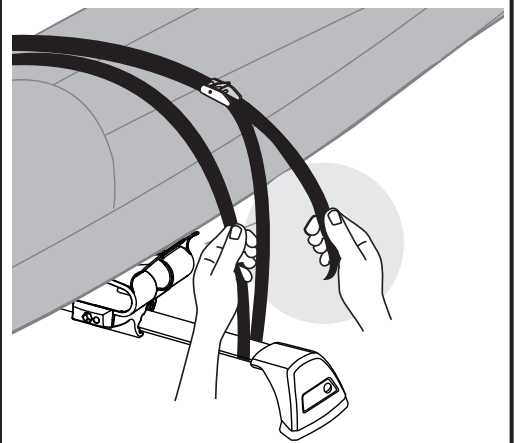

10 Tie one end of each rope to each hook

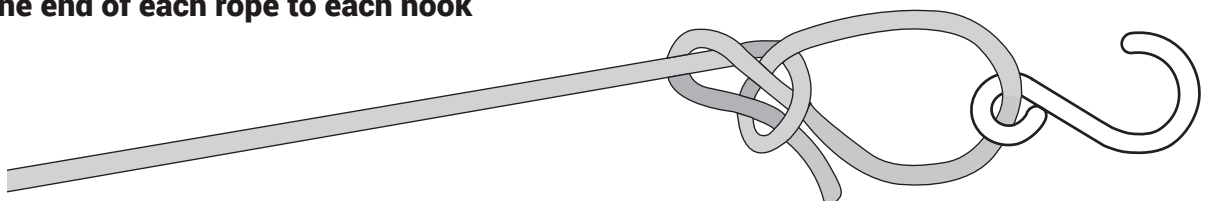

11 Attach one hook to front of vehicle

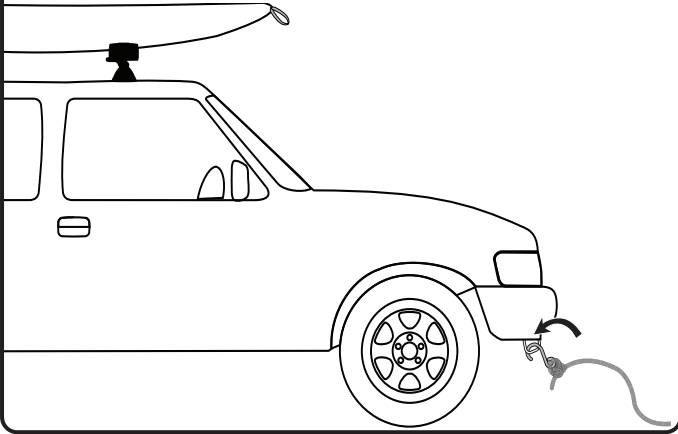

12 Attach the other hook to rear of vehicle

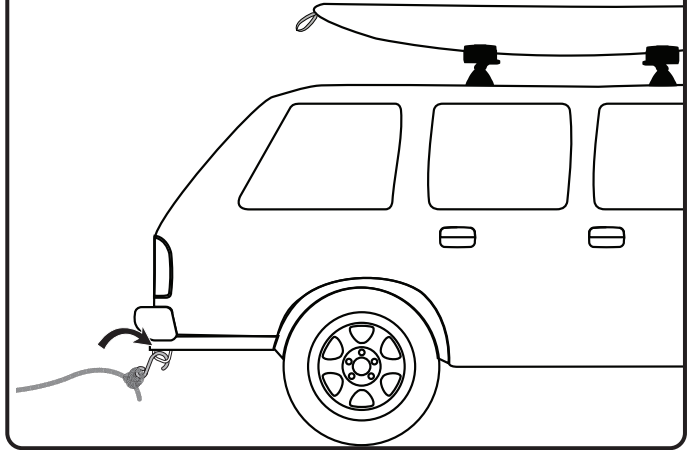

13 Secure front and rear of kayak to vehicle

Attach ropes to grab handle or rescue bar and pull tight.

Securely tie off ends to create even pressure between front and rear. Bind up and secure excess rope.

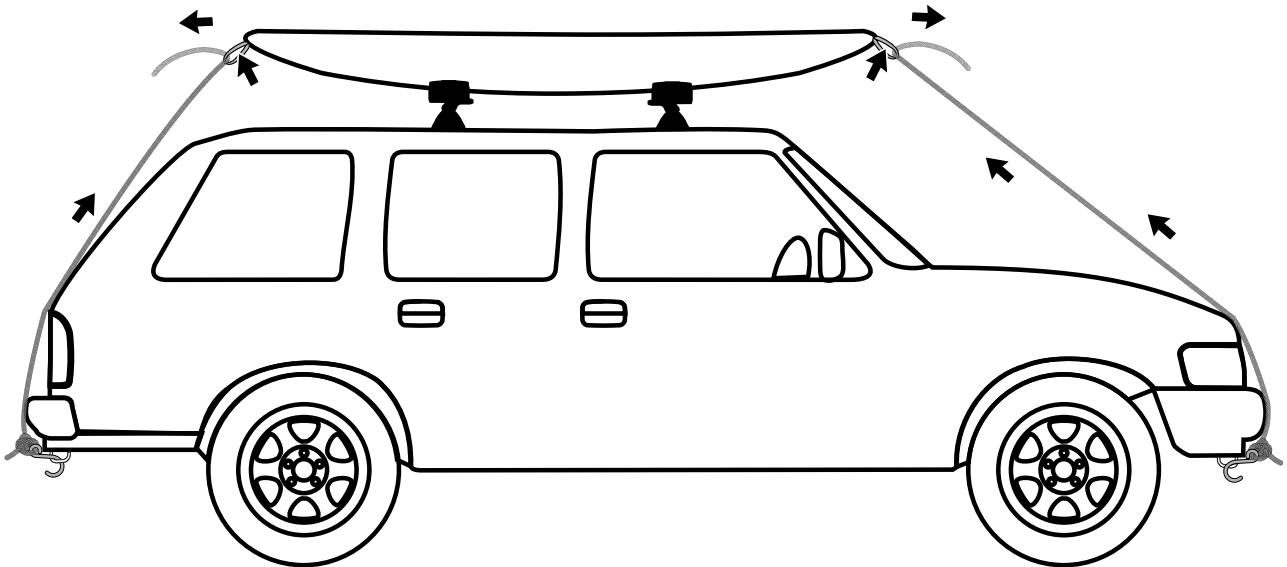

Safety Checks

- Before Driving Away:
 - Ensure all hardware is secured according to instructions.
 - Test movement by rocking boat.
 - Tighten again if loose.
- Attachment hardware can loosen over time:
 - Check straps periodically during travel and tighten if necessary.
 - Replace any straps that are worn or frayed before using (see your Prorack dealer).
- Some longer loads may prevent the rear hatch from fully opening.

Always use caution when opening your hatch.



Care and Maintenance

- Use non-water soluble lubricant on screws. Use a soft cloth with water and mild detergent to clean plastic parts.



Prorack
17 Hinkler Court, Brendale
QLD 4500, Australia

Freephone
AU: 1800 143 548
NZ: 0800 4776 722

www.prorack.com.au
www.prorack.co.nz

ALL CONTENT SUBJECT TO YAKIMA AUSTRALIA PTY LTD COPYRIGHT © 2014